

User's Manual

ColorEdge®

CG301W

Calibration Color LCD Monitor

Important

Please read this User's Manual carefully to familiarize yourself with safe and effective usage.





The latest User's Manual is available for download from our site:
<http://www.eizo.com>

SAFETY SYMBOLS	2
 PRECAUTIONS	3
1. Introduction	7
1-1. Features	7
1-2. Buttons and Indicators	8
1-3. Utility Disk	9
2. Installation.....	10
2-1. Environmental Settings	10
2-2. Making Use of USB (Universal Serial Bus)	12
3. Screen Adjustment and Settings	13
3-1. Basic Operation and Functions	13
3-2. Color Adjustment.....	15
3-3. Power-save Setup	18
3-4. Off Timer	19
3-5. Locking the Settings	19
3-6. Power Indicator Setting	20
3-7. Displaying Lower Resolutions	20
3-8. Setting the Orientation of the Adjustment Menu	21
3-9. Displaying EIZO Logo	21
4. Troubleshooting	22
5. Reference	24
5-1. Attaching an Arm.....	24
5-2. Cleaning	25
5-3. Specifications	26
5-4. Glossary	29
FCC Declaration of Conformity.....	31
Hinweise zur Auswahl des richtigen Schwenkarms für Ihren Monitor / Hinweis zur Ergonomie.....	32
How to Setup Please read the Setup Manual (separate volume)	



SAFETY SYMBOLS

This manual uses the safety symbols below. They denote critical information. Please read them carefully.

	WARNING Failure to abide by the information in a WARNING may result in serious injury and can be life threatening.
	CAUTION Failure to abide by the information in a CAUTION may result in moderate injury and/or property or product damage.
	Indicates a prohibited action.
	Indicates to ground for safety.

Copyright© 2007-2009 EIZO NANA O CORPORATION All rights reserved. No part of this manual may be reproduced, stored in a retrieval system, or transmitted, in any form or by any means, electronic, mechanical, or otherwise, without the prior written permission of EIZO NANA O CORPORATION.

EIZO NANA O CORPORATION is under no obligation to hold any submitted material or information confidential unless prior arrangements are made pursuant to EIZO NANA O CORPORATION's receipt of said information. Although every effort has been made to ensure that this manual provides up-to-date information, please note that EIZO monitor specifications are subject to change without notice.

Apple, Macintosh, Mac OS and ColorSync are registered trademarks of Apple Inc.

VGA is a registered trademark of International Business Machines Corporation.

VESA is a registered trademark or a trademark of Video Electronics Standards Association in the United States and other countries.

Windows and Windows Vista are registered trademarks of Microsoft Corporation in the United States and other countries.

PowerManager and ColorNavigator are trademarks of EIZO NANA O CORPORATION.

ScreenManager, ColorEdge and EIZO are registered trademarks of EIZO NANA O CORPORATION in Japan and other countries.

Product specifications may vary depending on the region.

Confirm the specifications in the manual written in the language of the region of purchase.

PRECAUTIONS

IMPORTANT!

- This product has been adjusted specifically for use in the region to which it was originally shipped. If operated outside the region to which it was originally shipped, the product may not perform as stated in the specifications.
This product is designed for use in Japan only and cannot be used in any other countries.
- To ensure personal safety and proper maintenance, please read this section and the caution statements on the unit (refer to the figure below).

[Location of the Caution Statements]

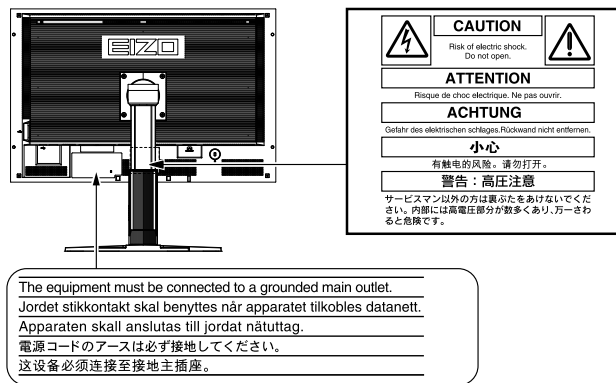

WARNING

If the unit begins to emit smoke, smells like something is burning, or makes strange noises, disconnect all power connections immediately and contact your dealer for advice.

Attempting to use a malfunctioning unit may result in fire, electric shock, or equipment damage.

Do not open the cabinet or modify the unit.

Opening the cabinet or modifying the unit may result in fire, electric shock, or burn.



Refer all servicing to qualified service personnel.

Do not attempt to service this product yourself as opening or removing covers may result in fire, electric shock, or equipment damage.

Keep small objects or liquids away from the unit.

Small objects accidentally falling through the ventilation slots into the cabinet or spillage into the cabinet may result in fire, electric shock, or equipment damage. If an object or liquid falls/spills into the cabinet, unplug the unit immediately. Have the unit checked by a qualified service engineer before using it again.

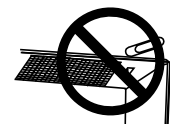

 **WARNING**

Place the unit at the strong and stable place.

A unit placed on an inadequate surface may fall and result in injury or equipment damage.

If the unit falls, disconnect the power immediately and ask your dealer for advice. Do not continue using a damaged unit. Using a damaged unit may result in fire or electric shock.

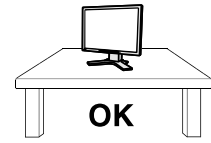

Set the unit in an appropriate location.

Not doing so may result in fire, electric shock, or equipment damage.

- Do not place outdoors.
- Do not place in the transportation system (ship, aircraft, trains, automobiles, etc.)
- Do not place in a dusty or humid environment.
- Do not place in a location where the steam comes directly on the screen.
- Do not place near heat generating devices or a humidifier.
- Do not place in an inflammable gas environment.

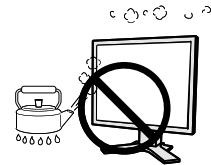

To avoid danger of suffocation, keep the plastic packing bags away from babies and children.

Use the enclosed power cord and connect to the standard power outlet of your country.

Be sure to remain within the rated voltage of the power cord. Not doing so may result in fire or electric shock.

Power supply: 100-120/200-240 Vac, 50/60 Hz

To disconnect the power cord, grasp the plug firmly and pull.

Tugging on the cord may damage and result in fire or electric shock.

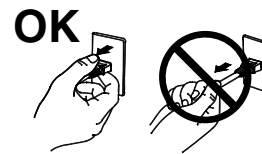

The equipment must be connected to a grounded main outlet.

Not doing so may cause in fire or electric shock.



Use the correct voltage.

- The unit is designed for use with a specific voltage only. Connection to another voltage than specified in this User's Manual may cause fire, electric shock, or equipment damage.

Power supply: 100-120/200-240 Vac, 50/60 Hz

- Do not overload your power circuit, as this may result in fire or electric shock.

Handle the power cord with care.

- Do not place the cord underneath the unit or other heavy objects.
- Do not pull on or tie the cord.

If the power cord becomes damaged, stop using it. Use of a damaged cord may result in fire or electric shock.



Never touch the plug and power cord if it begins to thunder.

Touching them may result in electric shock.



WARNING

When attaching an arm stand, please refer to the user's manual of the arm stand and install the unit securely.

Not doing so may cause the unit to come unattached, which may result in injury or equipment damage. When the unit is dropped, please ask your dealer for advice. Do not continue using a damaged unit. Using a damaged unit may result in fire or electric shock. When reattaching the tilt stand, please use the same screws and tighten them securely.

Do not touch a damaged LCD panel directly with bare hands.

The liquid crystal which leaks from the panel is poisonous if it enters the eyes or mouth.

If any part of the skin or body comes in direct contact with the panel, please wash thoroughly. If some physical symptoms result, please consult your doctor.



Lamps contain mercury, dispose according to local, state or federal laws.

CAUTION

Handle with care when carrying the unit.

Disconnect the power cord and cables when moving the unit. Moving the unit with the cord attached is dangerous. It may result in injury.

Carry or place the unit according to the correct specified methods.

- When carrying the unit, grasp and hold firmly as shown in the illustration below.
- Do not unpack or carry the unit only by a single person, since the large size unit is so heavy.

Dropping the unit may result in injury or equipment damage.

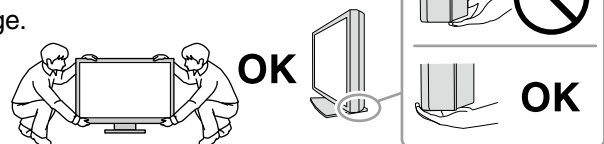

Do not block the ventilation slots on the cabinet.

- Do not place any objects on the ventilation slots.
- Do not install the unit in a closed space.
- Do not use the unit laid down or upside down.

Blocking the ventilation slots prevents proper airflow and may result in fire, electric shock, or equipment damage.



Do not touch the plug with wet hands.

Doing so may result in electrical shock.



Use an easily accessible power outlet.

This will ensure that you can disconnect the power quickly in case of a problem.

Periodically clean the area around the plug.

Dust, water, or oil on the plug may result in fire.

Unplug the unit before cleaning it.

Cleaning the unit while it is plugged into a power outlet may result in electric shock.

If you plan to leave the unit unused for an extended period, disconnect the power cord from the wall socket after turning off the power switch for the safety and the power conservation.

Notice for this monitor

In order to suppress the luminosity change by long-term use and to maintain the stable luminosity, use of a monitor in lower brightness is recommended.

The LCD panel is manufactured using high-precision technology. However, missing pixels or lit pixels may appear on the LCD panel, this is not malfunction. Percentage of effective pixels : 99.9994% or higher.

The backlight of the LCD panel has a fixed life span. When the screen becomes dark or begins to flicker, please contact your dealer.

Do not press on the panel or edge of the frame strongly, as this may result in damage to the screen. There will be prints left on the screen if the pressed image is dark or black. If pressure is repeatedly applied to the screen, it may deteriorate or damage your LCD panel. Leave the screen white or black to decrease the prints.

When the screen image is changed after displaying the same image for extended periods of time, an afterimage may appear. Use the screen saver or timer to avoid displaying the same image for extended periods of time.

When the monitor is cold and brought into a room or the room temperature goes up quickly, dew condensation may occur inside and outside the monitor. In that case, do not turn the monitor on and wait until dew condensation disappears, otherwise it may cause some damages to it.

Do not scratch or press on the panel with any sharp objects, such as a pencil or pen as this may result in damage to the panel. Do not attempt to brush with tissues as this may scratch the LCD panel.

To use the monitor comfortably

An excessively dark or bright screen may affect your eyes. Adjust the brightness of the monitor according to the environmental conditions.

Staring at the monitor for a long time tires your eyes. Take a 10-minute rest every hour.

1. Introduction

Thank you very much for choosing an EIZO Color Monitor.

1-1. Features

- 29.8 inch class wide screen format LCD
- Wide color gamut of 97% of Adobe RGB
- WQXGA (2560 × 1600) display compliant
- HDCP signal (SIGNAL2) compliant
- Dual-display compliant by introducing dual-input system (DVI-D × 2 connectors)
- DVI digital input (TMDS) compliant
- Horizontal scan frequency: 26 - 100 kHz
- Vertical scan frequency: 29.5 - 30.5Hz, 59 - 61Hz (VGA TEXT: 69 - 71 Hz)
- Resolution: 2560 dots × 1600 lines
- Compatible with frame synchronization mode*¹ (29.5 - 30.5Hz, 59 - 61Hz)
- Smoothing (soft - sharp) function
- The provided "ColorNavigator" calibration software enables you to calibrate monitor characteristics and generate ICC profiles (for Windows) and Apple ColorSync profiles (for Macintosh) (refer to the EIZO LCD Utility Disk)
- FineContrast modes, to select the most suitable mode for screen display
- Height adjustable stand
- Portrait/Landscape display available (rotate 90 degrees clockwise)
- Attaching the "Adjustment Certificate" to describe the grayscale and uniformity characteristics of the monitor individually
- Monitor hood attached
- Color Vision Deficiency Simulation Software "UniColor Pro" supported (This software can be downloaded from <http://www.eizo.com>)

*¹ Compatible frequency differs depending on your graphics board.

Tips

- This monitor supports the Portrait/Landscape display. This function allows you to change the orientation of the Adjustment menu when using the monitor screen in vertical display position. (Refer to "3-8. Setting the Orientation of the Adjustment Menu" on page 21.)
 - If you use the monitor with "Portrait" position, the setting may be required to change depending on the graphics board used in your PC. Refer to the manual of the graphics board for details.
-

1-2. Buttons and Indicators

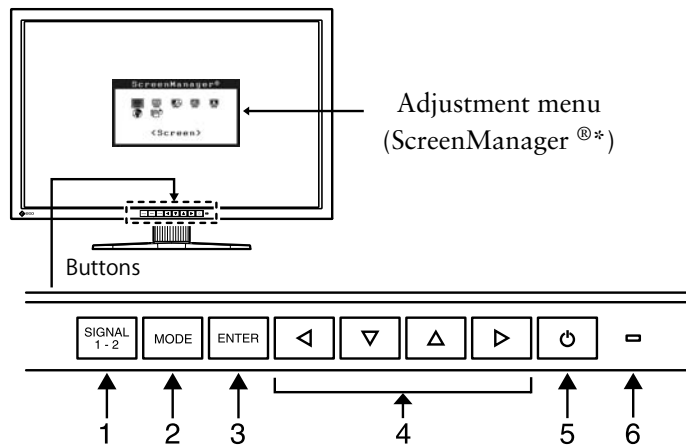

1. Input Signal Selection button
2. Mode button
3. Enter button
4. Control buttons (Left, Down, Up, Right)
5. Power button
6. Power indicator

Indicator status	Operation status
Blue	The screen is displayed
Flashing blue (2 times for each)	When the timer is set for ColorNavigator, notifies that a recalibration is required (for CAL mode or EMU mode)
Orange	Power saving
Off	Power off

*ScreenManager® is an EIZO's nickname of the Adjustment menu.

1-3. Utility Disk

An "EIZO LCD Utility Disk" (CD-ROM) is supplied with the monitor. The following table shows the disk contents and the overview of the application software programs.

Disk contents and software overview

The disk includes software programs for adjustment and User's Manual. Refer to "Readme.txt" or the "read me" file on the disk for software startup procedures or file access procedures.

Item	Overview	For Windows	For Macintosh
A "Readme.txt" or "read me" file		√	√
ColorNavigator	An application software for calibrating monitor characteristics and generating ICC profiles (for Windows) and Apple ColorSync profiles (for Macintosh). (A PC must be connected to the monitor with the supplied USB cable.) Refer to the description later.	√	√
Screen Adjustment Utility	Monitor pattern display software used when adjusting the image of the analog input signal manually.	√	–
Screen adjustment pattern files	Used when adjusting the image of the analog signal input manually. If the Screen Adjustment Utility is not applicable to your PC, use this pattern files to adjust the image.	√	–
User's Manual (PDF file)		√	√

To use ColorNavigator

Refer to the corresponding User's Manual on the CD-ROM disk in order to install and use the software. When using this software, you will need to connect a PC to the monitor with the supplied USB cable. For more information refer to the "2-2. Making Use of USB (Universal Serial Bus)" (page 12).

2. Installation

2-1. Environmental Settings

Depending upon your operating environment, it may be necessary to set the frequency that corresponds to your graphics board. If you install it for the first time or change environment, set the monitor.

NOTE

- Factory default settings are for single display mode and Dual Link.
- We recommend using ColorNavigator with single display mode in landscape orientation.
- Refer to the manual of the graphics board.
- These environment described below can be set regardless of whether or not the computer is running.

Displaying Two Screens Simultaneously

It is possible to display two screens on a single monitor at the same time by using one graphics board with DVI-D2 type output or two graphics boards with DVI-D output on the same computer.

Dual display with 1200 × 1600 resolution is the maximum display size.



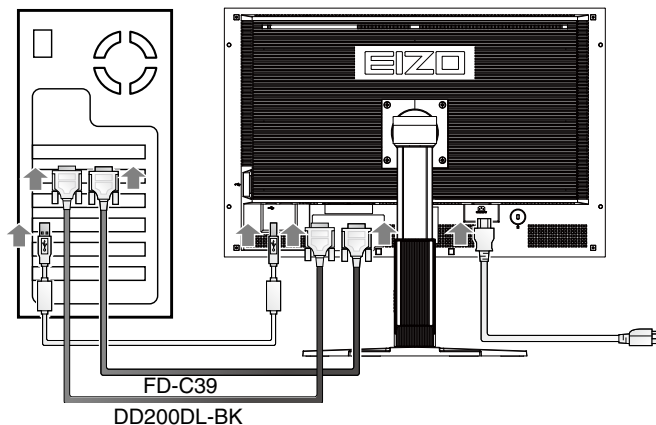

How to set

- 1 Connect the [SIGNAL1] signal input connector and the computer using the [DD200DL-BK] signal cable.
- 2 Connect the [SIGNAL2] signal input connector and the computer using the [FD-C39] signal cable.

After connecting the cable connectors, tighten the screws of the connectors to secure the coupling.



Connectors on the PC	Signal cable	Connectors on the monitor
	Signal cable (DD200DL-BK) 	SIGNAL1
	Signal cable (FD-C39) 	SIGNAL2

- 3 Hold down the  button and press the  button.
- 4 The <Display Setup> menu will appear in the middle of the screen. Press the   buttons to select "Dual Display" and then press .

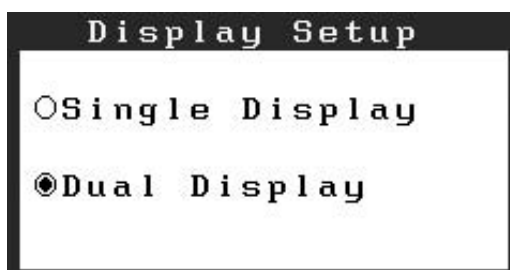



Inputting 10 bit Color Signal







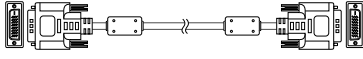

Some graphics boards support 10 bit color signal input.

How to set

- 1 Connect the [SIGNAL1] signal input connector and the computer using the [DD200DL-BK] signal cable.

After connecting the cable connectors, tighten the screws of the connectors to secure the coupling.

Connectors on the PC	Signal cable	Connectors on the monitor
	Signal cable (DD200DL-BK) 	

- 2 Hold down the  button and press the  button.
- 3 The <Display Setup> menu will appear in the middle of the screen. Press the   buttons to select "Single Display" and then press .
- 4 The <Signal Selection> menu will appear. Press the   buttons to select "Single Link/10bit", and press .

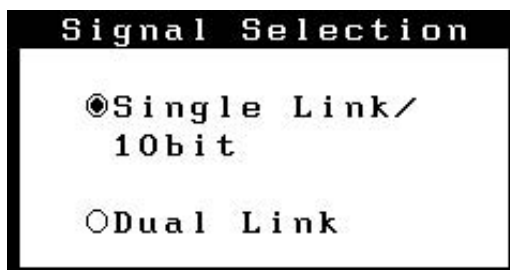

2-2. Making Use of USB (Universal Serial Bus)

This monitor provides a hub which supports the USB standard. When connecting to a USB compliant PC or another hub, the monitor functions as a hub to which the USB compliant peripherals can be easily connected.

Required system environment

- PC equipped with USB ports or another USB hub connected to the USB compliant PC
- Windows 2000/XP/Vista // Mac OS 9.2.2 and Mac OS X 10.2 or later
- USB Cable (MD-C93, enclosed)

NOTE

- The USB hub function may not work properly depending on the PC or peripherals. Please consult the manufacturer of each device about the USB support.
 - Using the USB Rev. 2.0 compatible PC or peripherals is recommended.
 - If the monitor is in the power saving mode, or if the monitor is connected to the power outlet with the monitor turned off, all the devices connected to the USB ports (upstream and downstream) work. Therefore, power consumption of the monitor varies with connected devices even in the power saving mode.
 - The followings are procedures for the Windows2000/XP/Vista and Mac OS.
-

Connecting to the USB HUB

- 1** Connect the monitor to the PC with the signal cable first, then turn on the PC.
- 2** Connect the upstream port of the monitor to the downstream port of the USB compliant PC or another hub by using the USB cable.
After connecting the USB cable, the USB function can be set up automatically.
- 3** After setting up, the monitor's USB hub is available for connecting USB compliant peripherals to the downstream ports of the monitor.

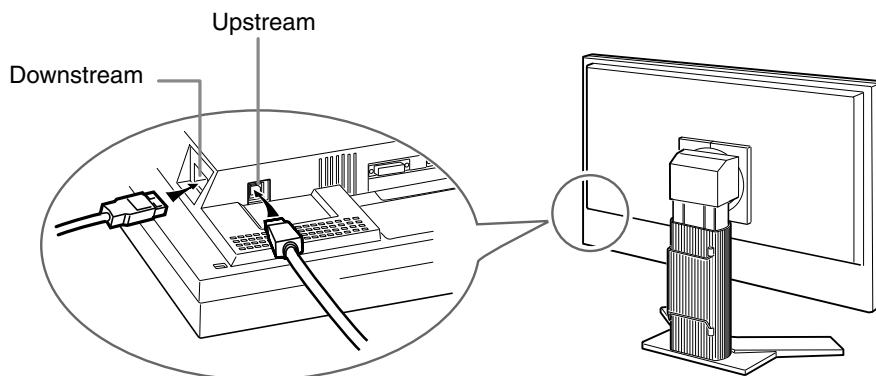

3. Screen Adjustment and Settings

3-1. Basic Operation and Functions

ScreenManager allows you to adjust screen performance through the main menu and select a FineContrast mode easily.

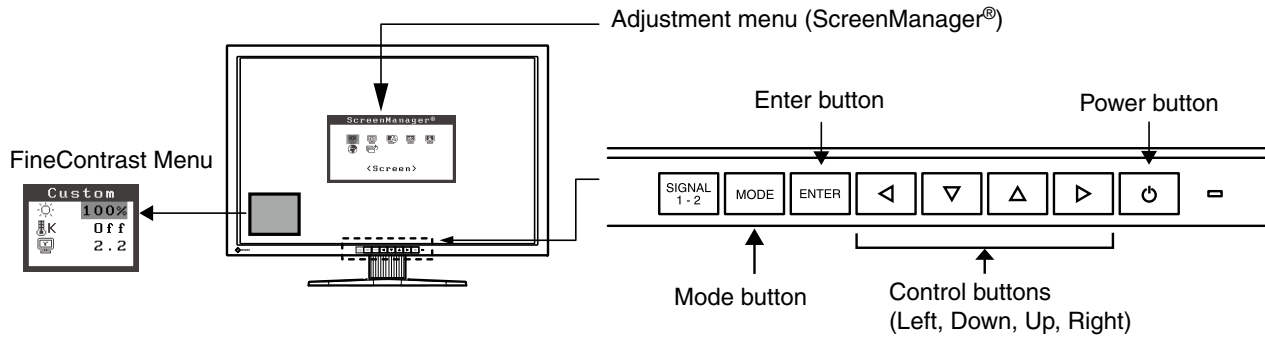

NOTE

- The Adjustment menu and the FineContrast menu cannot be displayed at the same time.

1 Entering the ScreenManager

Press **ENTER** once to display the main menu of the ScreenManager.

2 Making Adjustments and Settings

1. Select the desired sub menu icon using **◀ ▼ ▲ ▶** and press **ENTER**. The sub menu appears.
2. Use **◀ ▼ ▲ ▶** to select the desired setting icon and press **ENTER**. The setting menu appears.
3. Use **◀ ▼ ▲ ▶** to make all required adjustments and press **ENTER** save the settings.

3 Exiting the ScreenManager

1. To return to the main menu, select the <Return> icon or press **▼** twice, followed by **ENTER**.
2. To exit the ScreenManager, select <Exit> icon or press **▼** twice, followed by **ENTER**.

Tips

- Double clicking **ENTER** at any time also exits the ScreenManager menu.

Functions

The following table shows all the ScreenManager's adjustment and setting menus.

Main menu	Sub menu	Reference	
Screen	Smoothing	3-7. Displaying Lower Resolutions	
Color(Custom)* ¹	Brightness	3-2. Color Adjustment	
	Temperature		
	Gamma		
	Saturation		
	Hue		
	Gain		
	6 Colors		
	Reset		
PowerManager	DVI DMPM	3-3. Power-save Setup	
	OFF		
Others	Screen Size	3-7. Displaying Lower Resolutions	
	Border Intensity		
	Input Signal	Set the input signal selection of automatic or manual.	
	Off Timer	Set the monitor's Off Timer to on or off.	
	Beep	Set the monitor's beeper to on or off. (Beeper settings.)	
	Menu Settings	Menu Size	Change the size of the menu.
		Menu Position	Adjust the menu position.
		Menu Off Timer	Set the menu displaying time.
		Translucent	Set the transparency of the background.
		Orientation	Set the orientation of the Adjustment menu.
	Power Indicator	Make non-light for blue lighting when the screen is displayed (Power Indicator Setting).	
	Reset	Return to the factory Default settings.	
Information	Information	Review the ScreenManager's settings, model name, serial number and usage time.* ²	
Language	English, German, French, Spanish, Italian, Swedish, Chinese(Simplified), Chinese(Traditional) and Japanese	Select the ScreenManager's language.	

*¹The adjustable functions on the <Color> menu depend on the selected FineContrast mode. The above table shows the sub menus when the "Custom" mode is selected (See "3-2. Color Adjustment").

*²Due to the inspection on the factory, the usage time may not "0 hour" at shipping.

3-2. Color Adjustment

Simple Adjustment [FineContrast mode]

This function allows you to select the best display mode for monitor brightness, etc.

To select FineContrast mode

Directly pressing **[MODE]** allows you to select the best suited mode for screen display from 4 FineContrast modes; Custom, sRGB, EMU, and CAL.

Press **[ENTER]** to exit the menu.

>Custom -> sRGB -> EMU -> CAL

Tips

- The Adjustment menu and the FineContrast menu cannot be displayed at the same time.

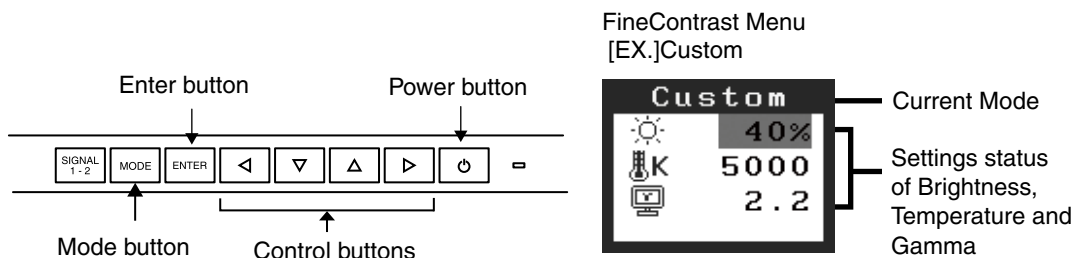

FineContrast Mode

Selectable FineContrast modes are as follows.

Mode	Purpose
Custom	To adjust the color settings according to your preference
sRGB	To display the screen images based on those original colors (ex. over the Internet).
EMU	The mode only for calibration software
CAL	

Color Adjustment of the Mode Settings

<Brightness>, <Temperature> and <Gamma> settings can be adjusted on the FineContrast menu. Select the desired function icon with **[▽] [▲]** and adjust with **[◀] [▶]**. (Setting(s) of <Temperature> and/or <Gamma> is defined as standard default in some modes.

NOTE

- "EMU" mode and "CAL" mode can be adjusted only by Calibration Software.









Advanced Adjustments[Adjustment menu]

Color settings of each FineContrast mode can be adjusted and saved by using the <Color> menu of the Adjustment menu.

Adjustment Items

The adjustable items and displayed icons on the <Color> menu depend on the selected FineContrast mode.

"√": Settable/Adjustable " - ": Fixed at the factory









Icons	Functions	FineContrast Mode			
		Custom	sRGB	EMU	CAL
	Brightness*	√	√	—	—
	Temperature*	√	—	—	—
	Gamma*	√	—	—	—
	Saturation	√	—	—	—
	Hue	√	—	—	—
	Gain	√	—	—	—
	6 colors	√	—	—	—
	Reset	√	—	—	—

* These settings can be also adjusted on the FineContrast menu.

NOTE

- Allow the LCD monitor to stabilize for at least 30 minutes before making image adjustments. (Allow the monitor to warm up for at least 30 minutes before making adjustments.)
- The values shown in percentages represent the current level within the specific adjustment. They are available only as a reference tool. (To create a uniform white or black screen, the percentages for each will probably not be the same.)

Adjustment Contents

Menu	Function Descriptions	Adjustable range
Brightness 	To set the brightness of the screen	0~100%
	Tips <ul style="list-style-type: none"> • The values shown in the “%” are available only as reference. 	
Temperature 	To set the color temperature	4000K~10000K in 500 K increments (including 9300 K)
	Tips <ul style="list-style-type: none"> • The values shown in the Kelvin are available only as a reference tool. • While color temperature is adjusted, <Gain> is adjusted automatically according to the color temperature. • Setting the temperature under 4000 K or over 10000 K invalidates the color temperature setting. (The color temperature's setting turns "OFF".) • Setting the <Gain> invalidates the <Temperature> adjustment. 	
Gamma 	To set the gamma value	1.8~2.6
Saturation 	To change the saturation	-100~100 Setting the minimum level (-100) turns the image to the monochrome.
	NOTE <ul style="list-style-type: none"> • The <Saturation> adjustment may cause undisplayable color tone. 	
Hue 	To change the flesh color, etc.	-100~100
	NOTE <ul style="list-style-type: none"> • Using <Hue> adjustment may not obtain proper tone reproduction. 	
Gain 	To change each color (red, green and blue)	0~100% By adjusting the red, green and blue color tones for each mode, custom colors can be defined. Display a white or gray background image and adjust the <Gain>.
	Tips <ul style="list-style-type: none"> • The values shown in the “%” are available only as reference. • The <Temperature> setting invalidates this setting. The <Gain> setting varies with color temperature. 	
6 colors 	To adjust <Saturation> and <Hue> in each color (Red, Yellow, Green, Cyan, Blue and Magenta)	Hue: -100 ~ 100 Saturation: -100 ~ 100
Reset 	To reset the color settings of the selected FineContrast mode to the default settings.	

3-3. Power-save Setup

The <PowerManager> menu in the ScreenManager enables to set the power-save setup.

NOTE

- Do your part to conserve energy, turn off the monitor when you are finished using it. Disconnecting the monitor from the power supply is recommended to save energy completely.
 - Even if the monitor is in a power saving mode, USB compliant devices function when they are connected to the monitor's USB (both the upstream and the downstream ports). Therefore, power consumption of the monitor will change according to the connected devices even if the monitor is in a power saving mode.
-

This monitor complies with the "DVI DMPM"

[Procedure]

1. Set the PC's power saving settings.
2. Select "DVI DMPM" from the <PowerManager> menu.

[Power Saving System]

The monitor enters the power saving mode in five seconds in connection with the PC setting.

PC	Monitor	Power Indicator
Operation	Operation	Blue
Power saving	Power saving	Orange

[Power Resumption Procedure]

Operate the mouse or keyboard to return to a normal screen.

3-4. Off Timer

The off timer function causes the monitor to automatically enter a power off state after a predetermined amount of time has lapsed. This function was created to reduce Afterimage characteristics that are particular to LCD monitors when the monitor screen is left on for a long period without use.

[Procedure]

1. Select <Off Timer> in the ScreenManager <Others> menu.
2. Select "Enable" and touch the Right and Left directing switches to adjust the operating time (1 to 23 hours).

[Off Timer System]

PC	Monitor	Power Indicator
Operating time (1H - 23H)	Operation	Blue
Last 15 min. in operating time	Advance Notice ^{*1}	Blue Flashing
Operating time expired	Power Off	Off

*1 When  is pressed during the advance notice period, the monitor continues to operate for additional 90 minutes. Extension of operation time can be set without limitation.

[Power Resumption Procedure]







Press  to return a normal screen.

NOTE



- The off timer function works while the PowerManager is active, but there is no advance notice before the monitor's power is turned off.

3-5. Locking the Settings



Use the "Adjustment Lock" function to prevent any accidental changes.

Buttons that can be locked	<ul style="list-style-type: none"> •  (Enter button) / Adjustments/settings using Adjustment menu •  (Mode button) •  +  Display setup (P.11)
Buttons that cannot be locked	<ul style="list-style-type: none"> •  (Input Signal Selection button) •  (Power button)

[How to lock]

1. Press  to turn off the unit.
2. Press  again while pressing  .
The screen is displayed with the adjustment lock.

[How to unlock]

1. Press  to turn off the unit.
2. Press  again while pressing  .
The screen is displayed with the adjustment lock released.

3-6. Power Indicator Setting

Light off the power indicator. This function is available for the multiple panels settings.

[Procedure]

1. Select <Power Indicator> in the ScreenManager <Others> menu.
2. Select "Disable".

3-7. Displaying Lower Resolutions



The lower resolutions are enlarged to full screen automatically. Using the <Screen Size> function in the <Others> menu enables to change the screen size.

NOTE

- When "Single Link/10bit" is selected on the <Signal Selection> menu and 10bit color signal is input (page 11), the <Screen Size> cannot be selected. The screen is displayed in the "Normal" mode.

1 Enlarge the screen size when displaying a low resolution.

→  Select the <Screen Size>.

Select the <Screen Size> in the <Others> menu and select the screen size by using  and .

Mode	Function
Full	Displays the picture on the screen in full, irrespective of the picture's resolution. Since the vertical resolution and the horizontal resolution are enlarged at different rates, some images may appear distorted.
Enlarged	Displays the picture on the screen in full, irrespective of the picture's resolution. Since the vertical resolution and horizontal resolution are enlarged at same rates, some horizontal or vertical image may disappear.
Normal	Displays the picture at the actual Screen resolution.

Example: Displaying Image size 1280 × 1024 when setting <Single Display> in <Display Setup>.

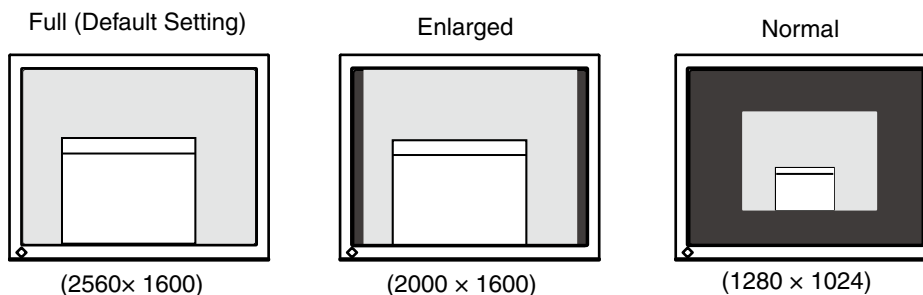

2 Smooth the blurred texts of the enlarged screen.

→  Switch the <Smoothing> setting.

When a low-resolution image is displayed in the "Full" or "Enlarged" mode, the characters or lines of the displayed image may be blurred.

Select the suitable level from 1 - 5 (Soft - Sharp).



Select <Smoothing> in the <Screen> menu and adjust by using the right and left switches.

NOTE

- Smoothing setting may not be required depending on the display resolution. (You cannot choose the smoothing icon.)

3 Set the brightness of the black area surrounding the displayed image.

→  Set the <Border Intensity>.

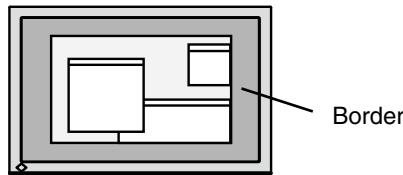

In the "Enlarge" mode or "Full Screen" mode, the outer area (border) is usually black. Select <BorderIntensity> in the <Others> menu and adjust by using  .



3-8. Setting the Orientation of the Adjustment Menu

The orientation of the Adjustment menu can be changed.

[Procedure]

1. Select <Menu Settings> in the ScreenManager <Others> menu.
2. Select <Orientation> in the <Menu Settings> menu.
3. Use   to select between "Portrait" and "Landscape".
4. Turn the monitor screen 90° in clockwise direction.

NOTE

- Be sure to turn the monitor screen after pulling up the screen to the uppermost position of the stand and setting the screen tilted upward.



Tips

- If you use the monitor with "Portrait" position, the setting may be required to change depending on the graphics board used in your PC. Refer to the manual of the graphics board for details.



3-9. Displaying EIZO Logo

When switching on the power button on the front control panel, the EIZO logo is displayed for a while. If you desire to display or undisplay this logo, use this function. (Default is logo appearing.)

[To undisplay]

1. Press  to turn off the unit.
 2. Press  again while pressing .
- The EIZO logo does not appear on the screen.









[To display]

1. Press  to turn off the unit.
 2. Press  again while pressing .
- The EIZO logo appear on the screen.

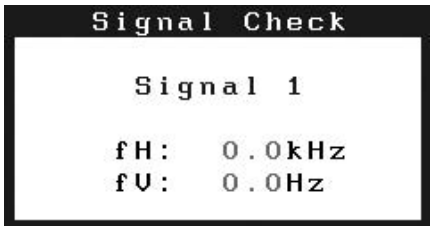
4. Troubleshooting

If a problem still remains after applying the suggested remedies, contact your local dealer.

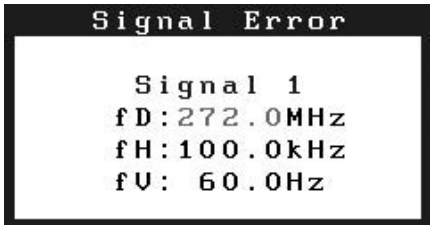
- No-picture problems : See No.1 - No.2
- Imaging problems : See No.3 - No.9
- Other problems : See No.10 - No.12
- USB problems : See No.13 - No.14

Problems	Possible cause and remedy
1. No picture <ul style="list-style-type: none"> • Power indicator does not light. 	<ul style="list-style-type: none"> • Check whether the power cord is connected correctly. If the problem persists, turn off the monitor, and then turn it on again a few minutes later. • Press .
<ul style="list-style-type: none"> • Power indicator is lighting blue. 	<ul style="list-style-type: none"> • Set each RGB adjusting value in <Gain> to higher level.(page 17).
<ul style="list-style-type: none"> • Power indicator is lighting orange. 	<ul style="list-style-type: none"> • Switch the input signal with . • Operate the mouse or keyboard. • Turn on the PC.
2. The message below appears. <ul style="list-style-type: none"> • This message appears when no signal is input. (This is displayed for about 40 seconds)  <p>* In Dual Display mode, the display of the error message is shown by  or .</p>	<p>This message appears when the signal is not input correctly even when the monitor functions properly.</p> <ul style="list-style-type: none"> • The message shown left may appear, because some PCs do not output the signal soon after power-on. • Check whether the PC is turned on. • Check whether the signal cable is connected properly. • Switch the input signal with .
<ul style="list-style-type: none"> • The message below shows that the input signal is out of the specified frequency range. (Such signal frequency is displayed in red.) Example:  <p>* In Dual Display mode, the display of the error message is shown by  or .</p>	<ul style="list-style-type: none"> • Reboot the PC. • Select an appropriate display mode using the graphics board's utility. Refer to the manual of the graphics board for details. fD: Dot Clock fH: Horizontal Frequency fV: Vertical Frequency
3. Characters are blurred.	<ul style="list-style-type: none"> • Adjust using <Smoothing> (page 20).
4. The screen is too bright or too dark.	<ul style="list-style-type: none"> • Adjust <Brightness>. (The LCD monitor backlight has a fixed life span. When the screen becomes dark or begins to flicker, contact your local dealer.)

Problems	Possible cause and remedy
5. Afterimages appear.	<ul style="list-style-type: none"> • Use a screen saver or off timer function for a long-time image display. • Afterimages are particular to LCD monitors. Avoid displaying the same image for a long time.
6. Green/red/blue/white dots or defective dots remain on the screen.	<ul style="list-style-type: none"> • This is due to LCD panel characteristics and is not a failure.
7. Interference patterns or fingerprints remain on the screen.	<ul style="list-style-type: none"> • Leave the monitor with a white screen or a black screen. The symptom may disappear.
8. Noise appears on the screen.	<ul style="list-style-type: none"> • When entering the signals of HDCP system, the normal images may not be displayed immediately.
9. The display image is appeared in lengthwise.	<ul style="list-style-type: none"> • Check whether the kind of cables connected with the monitor and the PC.
10. The <Smoothing> icon on the Adjustment menu <Screen> cannot be selected.	<ul style="list-style-type: none"> • Smoothing setting may not be required depending on the display resolution. (You cannot choose the smoothing icon.
11. The Main menu of Adjustment menu does not start.	<ul style="list-style-type: none"> • Check for Adjustment Lock function (page 19).
12. The FineContrast mode is not displayed.	<ul style="list-style-type: none"> • Check for Adjustment Lock function (page 19).
13. PC is hung up. / The peripherals connected to the downstream ports do not operate.	<ul style="list-style-type: none"> • Check that the USB cable is correctly connected. • Check the downstream ports by connecting the peripherals to other downstream ports. If the problem is solved by doing this, contact an EIZO dealer (For details, refer to the manual of the PC). • Try executing the following method. <ul style="list-style-type: none"> • Restarting the PC • Connecting the PC and peripherals directly • If the problem is solved by doing this, contact an EIZO dealer.
14. USB function cannot be setup.	<ul style="list-style-type: none"> • Check that the USB cable is correctly connected. • Check that the PC and OS are USB compliant (For verification of USB support, consult the manufacturer of each system). • Check the PC's BIOS setting for USB (For details, refer to the manual of the PC).

5. Reference

5-1. Attaching an Arm

The LCD monitor can be used with an arm by removing the tilt stand and attaching the arm stand to the LCD monitor.

NOTE

- When attaching an arm or stand, follow the instructions of their user's manual.
- When using another manufacturer's arm or stand, confirm the following in advance and select one conforming to the VESA standard. Use M4 × 12 mm screws supplied with the monitor.
 - Clearance between the screw holes: 100 mm × 100 mm
 - Thickness of plate: 2.6 mm
 - Strong enough to support weight of the monitor unit (except the stand) and attachments such as cables.
- Attach an arm or stand to meet the following tilt angles of the monitor.– Up 45 degrees, down 45 degrees (Within operating range)
- Connect the cables after attaching an arm.

Setup Procedure

- 1 Lay the LCD monitor on a soft cloth spread over on a stable surface with the panel surface facing down.**
- 2 Remove the stand. (Prepare a screwdriver.)**
Unscrew the four screws securing the unit and the stand with the screwdriver.
- 3 Attach the monitor to the arm or stand.**
Secure the stand to the monitor with four screws using a screwdriver.

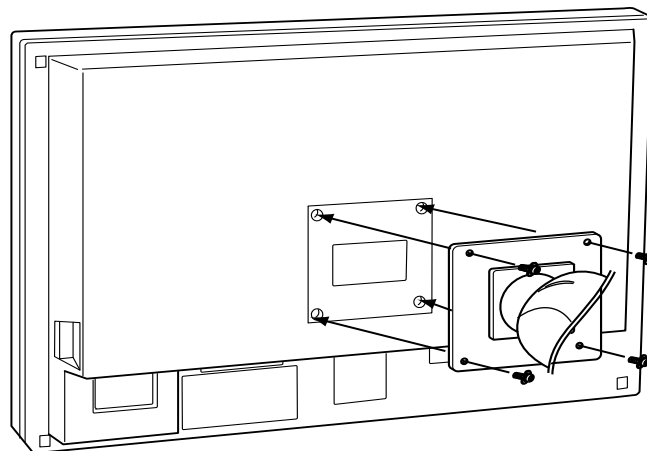

5-2. Cleaning

Periodic cleaning is recommended to keep the monitor looking new and to prolong its operation lifetime.

NOTE

- Never use thinner, benzene, alcohol, abrasive cleaners, or other strong solvents, as these may cause damage to the cabinet or LCD panel.
-

Cabinet

To remove stains, wipe the cabinet with a soft, lightly moistened cloth using a mild detergent. Do not spray wax or cleaner directly into the cabinet. (For details, refer to the manual of the PC.)

LCD Panel

- The LCD surface can be cleaned with a soft cloth, such as cotton or lens paper.
- If necessary, stubborn stains can be removed by using the provided ScreenCleaner, or moistening part of a cloth with water to enhance its cleaning power.

5-3. Specifications

LCD Panel		76 cm (29.8 inch), TFT color LCD panel Surface treatment : Anti-Glare Hard Coating Surface hardness : 3H Response Time : 12ms
Viewing Angle		Horizontal : 178°, Vertical : 178°(CR: 10 or more)
Dot Pitch		0.2505mm
Horizontal Scan Frequency		26~100 kHz
Vertical Scan Frequency		29.5 - 30.5Hz, 59 - 61Hz (VGA TEXT: 69 ~ 71 Hz)
Resolution		2560 dots x 1600 lines
Display Colors		16.77 million colors (max.)
Recommended Brightness		120cd/m ² or less (with color temperature of between 5000K to 6500K)
Display Area		641.2 mm (H) × 400.8 mm (V) (25.2" (H) x 15.8" (V))
Power Supply		100-120 VAC±10%, 50/60 Hz, 1.8A 200-240 VAC±10%, 50/60 Hz, 0.8A
Power Consumption		Max. :170 W (with USB) Min. (Normal) :81W (without USB) Power Saving Mode :Less than 2 W (for single signal input without USB) Power switch Off :1W or less
Input Signal Connector		SIGNAL 1:DVI-D, Dual Link SIGNAL 2:DVI-D, Single Link (HDCP compliant)
Input Signal (Digital)		TMDS
Signal registration		10
Plug & Play		VESA DDC 2B / EDID structure 1.3
Dimensions	with stand	689 mm (W) x 511.5 ~ 629.5 mm (H) x 254.7 mm (D) (27.1"(W) x 20.1" ~ 24.8" (H) x 10"(D))
	without stand	689 mm (W) x 450 mm (H) x 90 mm (D) (27.1"(W) x 17.7" (H) x 3.54"(D))
	with hood	699 mm (W) x 520 ~ 638 mm (H) x 406.5 mm (D) (27.5"(W) x 20.5" ~ 25.1" (H) x 16"(D))
Weight	with stand	15.7 kg (34.6 lbs.)
	without stand	11.2 kg (24.7 lbs.)
	with hood	17 kg (37.5 lbs.)
Environment Conditions	Temperature	Operating : 0°C ~ 35°C (32°F ~ 95°F) Storage : -20°C ~ 60°C (-4°F ~ 140°F)
		Humidity
	Pressure	Operating : 700 to 1060 hPa. Storage : 200 to 1060 hPa.
USB	standard	USB Specification Revision 2.0
	USB port	Upstream port x 1 Downstream port x 2
	Communication Speed	480 Mbps (high), 12 Mbps (full), 1.5 Mbps (low)
	Power Supply	Downstream: 500 mA for each (max.)

Dimensions

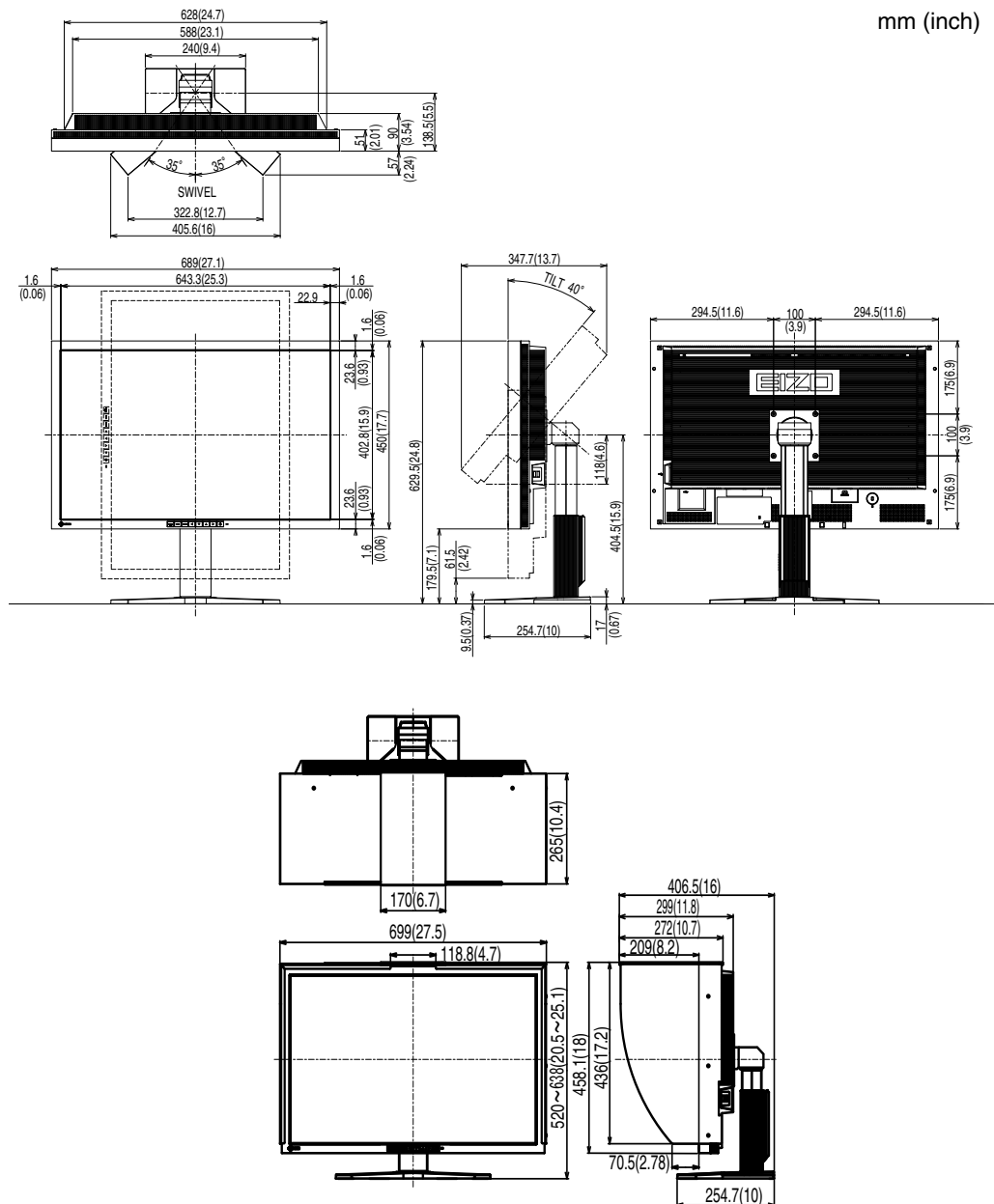

Default settings

Brightness		40%
Smoothing		3
Temperature		5000K
FineContrast Mode		Custom
PowerManager		DVI DMPM
Screen Size		Full
Off Timer		Disable
Menu Settings	Menu Size	Normal
	Menu Off Timer	45 seconds
Beep		On
Language		English
Display Setup		Single Display
Signal Selection		Dual Link

Pin Assignment

•DVI-D Connector

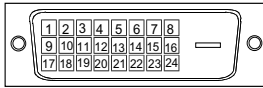

SIGNAL1 : Applicable to DualLink

Pin No.	Signal	Pin No.	Signal	Pin No.	Signal
1	T.M.D.S. Data 2-	9	T.M.D.S. Data1-	17	T.M.D.S. Data0-
2	T.M.D.S. Data 2+	10	T.M.D.S. Data1+	18	T.M.D.S. Data0+
3	T.M.D.S. Data2/4 Shield	11	T.M.D.S. Data1/3 Shield	19	T.M.D.S. Data0/5 Shield
4	T.M.D.S. Data 4-	12	T.M.D.S. Data 3-	20	T.M.D.S. Data 5-
5	T.M.D.S. Data 4+	13	T.M.D.S. Data 3+	21	T.M.D.S. Data 5+
6	DDC Clock (SCL)	14	+5V Power	22	T.M.D.S. Clock shield
7	DDC Data (SDA)	15	Ground (return for +5V, Hsync and Vsync)	23	T.M.D.S. Clock+
8	NC*	16	Hot Plug Detect	24	T.M.D.S. Clock-

(*NC: No Connection)

SIGNAL2 : Applicable to SingleLink only

Pin No.	Signal	Pin No.	Signal	Pin No.	Signal
1	T.M.D.S. Data 2-	9	T.M.D.S. Data1-	17	T.M.D.S. Data0-
2	T.M.D.S. Data 2+	10	T.M.D.S. Data1+	18	T.M.D.S. Data0+
3	T.M.D.S. Data2/4 Shield	11	T.M.D.S. Data1/3 Shield	19	T.M.D.S. Data0/5 Shield
4	NC*	12	NC*	20	NC*
5	NC*	13	NC*	21	NC*
6	DDC Clock (SCL)	14	+5V Power	22	T.M.D.S. Clock shield
7	DDC Data (SDA)	15	Ground (return for +5V, Hsync and Vsync)	23	T.M.D.S. Clock+
8	NC*	16	Hot Plug Detect	24	T.M.D.S. Clock-

(*NC: No Connection)

• USB Port

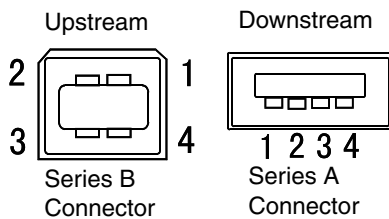

No.	Signal	Remarks
1	VCC	Cable power
2	- Data	Serial data
3	+ Data	Serial data
4	Ground	Cable Ground

5-4. Glossary

DVI (Digital Visual Interface)

A digital flat panel interface. DVI can transmit digital data from the PC directly without loss with the signal transition method "TMDS". There are two kinds of DVI connectors. One is DVI-D connector for digital signal input only. The other is DVI-I connector for both digital and analog signal inputs.

DVI DMPM (DVI Digital Monitor Power Management)

The Power management system for the digital interface. The "Monitor ON" status (operation mode) and the "Active Off" status (power-saving mode) are indispensable for the DVI-DMPM as the monitor's power mode.

Gain Adjustment

Adjusts each color parameter for red, green and blue. The color of the LCD monitor is displayed through the color filter of the LCD panel. Red, green and blue are the three primary colors. The colors on the monitor are displayed by combining these three colors. The color tone can change by adjusting the illumination amount passed through each color's filter.

Gamma

Generally, the relationship that the light intensity values of a monitor change nonlinearly to the input signal level is called "Gamma Characteristic". On the monitor, low gamma values display the whitish images and high gamma values display the high contrast images.

HDCP (High-bandwidth Digital Contents Protection)

Digital signal coding system developed to copy-protect the digital contents, such as video, music, etc. This helps to transmit the digital contents safely by coding the digital contents sent via DVI terminal on the output side and decoding them on the input side. Any digital contents cannot be reproduced if both of the equipments on the output and input sides are not applicable to HDCP system.

Resolution

The LCD panel consists of a fixed number of pixel elements which are illuminated to form the screen image. The display panel of this monitor consists of 2560 horizontal pixels and 1600 vertical pixels. At a resolution of 2560 x 1600, images are displayed as a full screen (1:1).

Temperature

Color Temperature is a method to measure the white color tone, generally indicated in degrees Kelvin. At high temperatures the white tone appears somewhat blue, while at lower temperatures it appears somewhat red. Computer monitors generally give best performance at high temperature settings.

5000 K: Slightly reddish white.

6500 K: Warm-white tone, similar to white paper or daylight.

9300 K: Slightly bluish white.

TMDS (Transition Minimized Differential Signaling)

A signal transition method for the digital interface.

VESA DPMS

(Video Electronics Standards Association - Display Power Management Signaling)

The acronym VESA stands for "Video Electronics Standards Association", and DPMS stands for "Display Power Management Signaling". DPMS is a communication standard that PCs and graphics boards use to implement power savings on the monitor side.

For U.S.A. , Canada, etc. (rated 100-120 Vac) Only

FCC Declaration of Conformity

We, the Responsible Party

EIZO NANAOTECHNOLOGIES INC.

5710 Warland Drive, Cypress, CA 90630

Phone: (562) 431-5011

declare that the product

Trade name: EIZO

Model: ColorEdge CG301W

is in conformity with Part 15 of the FCC Rules. Operation of this product is subject to the following two conditions: (1) this device may not cause harmful interference, and (2) this device must accept any interference received, including interference that may cause undesired operation.

This equipment has been tested and found to comply with the limits for a Class B digital device, pursuant to Part 15 of the FCC Rules. These limits are designed to provide reasonable protection against harmful interference in a residential installation. This equipment generates, uses, and can radiate radio frequency energy and, if not installed and used in accordance with the instructions, may cause harmful interference to radio communications. However, there is no guarantee that interference will not occur in a particular installation. If this equipment does cause harmful interference to radio or television reception, which can be determined by turning the equipment off and on, the user is encouraged to try to correct the interference by one or more of the following measures.

- * Reorient or relocate the receiving antenna.
- * Increase the separation between the equipment and receiver.
- * Connect the equipment into an outlet on a circuit different from that to which the receiver is connected.
- * Consult the dealer or an experienced radio/TV technician for help.

Changes or modifications not expressly approved by the party responsible for compliance could void the user's authority to operate the equipment.

Note

Use the attached specified cable below or EIZO signal cable with this monitor so as to keep interference within the limits of a Class B digital device.

- AC Cord
- Shielded Signal Cable (Enclosed)

Canadian Notice

This Class B digital apparatus complies with Canadian ICES-003.

Cet appareil numérique de la classe B est conforme à la norme NMB-003 du Canada.

Hinweise zur Auswahl des richtigen Schwenkarms für Ihren Monitor

Dieser Monitor ist für Bildschirmarbeitsplätze vorgesehen. Wenn nicht der zum Standardzubehör gehörige Schwenkarm verwendet wird, muss statt dessen ein geeigneter anderer Schwenkarm installiert werden. Bei der Auswahl des Schwenkarms sind die nachstehenden Hinweise zu berücksichtigen:

Der Standfuß muß den nachfolgenden Anforderungen entsprechen:

- a) Der Standfuß muß eine ausreichende mechanische Stabilität zur Aufnahme des Gewichtes vom Bildschirmgerät und des spezifizierten Zubehörs besitzen. Das Gewicht des Bildschirmgerätes und des Zubehörs sind in der zugehörigen Bedienungsanleitung angegeben.
- b) Die Befestigung des Standfusses muß derart erfolgen, daß die oberste Zeile der Bildschirmanzeige nicht höher als die Augenhöhe eines Benutzers in sitzender Position ist.
- c) Im Fall eines stehenden Benutzers muß die Befestigung des Bildschirmgerätes derart erfolgen, daß die Höhe der Bildschirmmitte über dem Boden zwischen 135 – 150 cm beträgt.
- d) Der Standfuß muß die Möglichkeit zur Neigung des Bildschirmgerätes besitzen (max. vorwärts: 5°, min. nach hinten $\geq 5^\circ$).
- e) Der Standfuß muß die Möglichkeit zur Drehung des Bildschirmgerätes besitzen (max. $\pm 180^\circ$). Der maximale Kraftaufwand dafür muß weniger als 100 N betragen.
- f) Der Standfuß muß in der Stellung verharren, in die er manuell bewegt wurde.
- g) Der Glanzgrad des Standfusses muß weniger als 20 Glanzeinheiten betragen (seidenmatt).
- h) Der Standfuß mit Bildschirmgerät muß bei einer Neigung von bis zu 10° aus der normalen aufrechten Position kippstabil sein.

Hinweis zur Ergonomie :

Dieser Monitor erfüllt die Anforderungen an die Ergonomie nach EK1-ITB2000 mit dem Videosignal, 2560 × 1600, Digital Eingang und mindestens 60,0 Hz Bildwiederholfrequenz, non interlaced. Weiterhin wird aus ergonomischen Gründen empfohlen, die Grundfarbe Blau nicht auf dunklem Untergrund zu verwenden (schlechte Erkennbarkeit, Augenbelastung bei zu geringem Zeichenkontrast.)

„Maschinenlärminformations-Verordnung 3. GPSGV:

Der höchste Schalldruckpegel beträgt 70 dB(A) oder weniger gemäss EN ISO 7779“



EIZO NANA O CORPORATION

153 Shimokashiwano, Hakusan, Ishikawa 924-8566 Japan
Phone: +81 76 277 6792 Fax: +81 76 277 6793

EIZO EUROPE AB

Lovangsvagen 14 194 61, Upplands Väsby, Sweden
Phone: +46 8 594 105 00 Fax: +46 8 590 91 575

<http://www.eizo.com>

4th Edition-July, 2009

03V22264D1
(U.M-CG301W)